



MOTORCYCLE KIT LIST 2004

No. KM 2573 General Motorcycle Kit For use on most motorcycles

| | | |
|-----|-------------------------------|-----------|
| 131 | Cutter— $.850''$ dia. | 45° |
| 132 | Cutter— $.830''$ dia. | 32° |
| 133 | Cutter— $.874''$ dia. | 60° |
| 122 | Cutter— $.975''$ dia. | 45° |
| 123 | Cutter— $.975''$ dia. | 31° |
| 111 | Cutter— $1''$ dia. | 60° |
| 120 | Cutter— $1''$ dia. | 15° |
| 270 | Cutter— $1\frac{1}{4}''$ dia. | 60° |
| 607 | Cutter— $1\frac{1}{2}''$ dia. | 30° |
| 608 | Cutter— $1\frac{1}{2}''$ dia. | 45° |
| 205 | Cutter— $1\frac{1}{2}''$ dia. | 60° |
| 626 | Cutter— $1\frac{1}{2}''$ dia. | 30° x 45° |
| 293 | Cutter— $1\frac{3}{4}''$ dia. | 60° |
| 645 | Cutter— $1\frac{3}{4}''$ dia. | 30° x 45° |

| | |
|-----------|--|
| 100-4,0 | Solid Pilot—4,0mm dia. |
| 100-4,02 | Solid Pilot—4,02mm dia. |
| 100-4,5 | Solid Pilot—4,5mm dia. |
| 100-4,52 | Solid Pilot—4,52mm dia. |
| 100-5,0 | Solid Pilot—5,0mm dia. |
| 100-5,02 | Solid Pilot—5,02mm dia. |
| 100-5,5 | Solid Pilot—5,5mm dia. |
| 100-5,52 | Solid Pilot—5,52mm dia. |
| 100-6,0 | Solid Pilot—6,0mm dia. |
| 100-6,6 | Solid Pilot—6,6mm dia. |
| 140-6,6 | Solid Pilot—6,6mm dia. |
| 140-6,98 | Solid Pilot—6,98mm dia. |
| 140-7,0 | Solid Pilot—7,0mm dia. |
| 140-7,02 | Solid Pilot—7,02mm dia. |
| 140-8,0 | Solid Pilot—8,0mm dia. |
| 140-8,02 | Solid Pilot—8,02mm dia. |
| 140-5/16 | Solid Pilot— $\frac{5}{16}''$ dia. -2, -1, Std., +1 |
| 140-11/32 | Solid Pilot— $\frac{11}{32}''$ dia. -2, -1, Std., +1 |
| 140-3/8 | Solid Pilot— $\frac{3}{8}''$ dia. -1, Std., +1, +2, +3, +4, +5 |

| | |
|---------|---|
| TW505 | T-Wrench |
| TW503-1 | Adaptor, $\frac{1}{8}''$ to $\frac{3}{8}''$ |
| CA497 | Case |
| KACC246 | Accessories Kit |

No. KM 2563 General Japanese Motorcycle Kit For use on most Japanese motorcycles

| | | |
|-----|-------------------------------|-----------|
| 132 | Cutter— $.830''$ dia. | 32° |
| 131 | Cutter— $.850''$ dia. | 45° |
| 133 | Cutter— $.874''$ dia. | 60° |
| 122 | Cutter— $.975''$ dia. | 45° |
| 123 | Cutter— $.975''$ dia. | 31° |
| 111 | Cutter— $1''$ dia. | 60° |
| 120 | Cutter— $1''$ dia. | 15° |
| 270 | Cutter— $1\frac{1}{4}''$ dia. | 60° |
| 607 | Cutter— $1\frac{1}{2}''$ dia. | 30° |
| 608 | Cutter— $1\frac{1}{2}''$ dia. | 45° |
| 205 | Cutter— $1\frac{1}{2}''$ dia. | 60° |
| 626 | Cutter— $1\frac{1}{2}''$ dia. | 30° x 45° |

| | |
|----------|-------------------------|
| 100-4,0 | Solid Pilot—4,0mm dia. |
| 100-4,5 | Solid Pilot—4,5mm dia. |
| 100-5,0 | Solid Pilot—5,0mm dia. |
| 100-5,5 | Solid Pilot—5,5mm dia. |
| 100-5,52 | Solid Pilot—5,52mm dia. |
| 100-6,0 | Solid Pilot—6,0mm dia. |
| 100-6,6 | Solid Pilot—6,6mm dia. |
| 140-5,0 | Solid Pilot—5,0mm dia. |
| 140-5,5 | Solid Pilot—5,5mm dia. |
| 140-6,6 | Solid Pilot—6,6mm dia. |
| 140-6,98 | Solid Pilot—6,98mm dia. |
| 140-7,0 | Solid Pilot—7,0mm dia. |
| 140-7,02 | Solid Pilot—7,02mm dia. |
| 140-8,0 | Solid Pilot—8,0mm dia. |
| 140-8,02 | Solid Pilot—8,02mm dia. |

| | |
|---------|---|
| TW505 | T-Wrench |
| TW503-1 | Adaptor, $\frac{1}{8}''$ to $\frac{3}{8}''$ |
| CA497 | Case |
| KACC246 | Accessories Kit |

No. KM 2450 for Harley-Davidson*

| | | |
|---------------------|--|-----------|
| †622H | Cutter— $1\frac{1}{2}''$ dia. | 31° x 46° |
| 205 | Cutter— $1\frac{1}{2}''$ dia. | 60° |
| 293 | Cutter— $1\frac{3}{4}''$ dia. | 60° |
| †642H | Cutter— $1\frac{3}{4}''$ dia. | 31° x 46° |
| 140- $\frac{5}{16}$ | Solid Pilot— $\frac{5}{16}''$ dia. -3, -2, -1, Std., +1 | |
| 140- $\frac{1}{2}$ | Solid Pilot— $\frac{1}{2}''$ dia. -4, -3, -2, -1, Std., +1 | |
| 140- $\frac{3}{4}$ | Solid Pilot— $\frac{3}{4}''$ dia. -2, -1, Std., +1, +2, +3, +4 | |
| TW505 | T-Wrench | |
| CA160 | Case | |
| KACC246 | Accessories Kit | |

No. KMU 470 Harley-Davidson V-Rod Upgrade Kit*

| | | |
|---------|-------------------------------|-----------|
| 203 | Cutter— $1\frac{1}{2}''$ dia. | 31° x 46° |
| 271 | Cutter— $1\frac{1}{2}''$ dia. | 70° |
| 140-6,0 | Solid Pilot—6,0mm dia. | |

No. KM 2299 for BMW*

| | | |
|-----|-------------------------------|-----------|
| 122 | Cutter— $.975''$ dia. | 45° |
| 125 | Cutter— $1''$ dia. | 75° |
| 126 | Cutter— $1''$ dia. | 30° |
| 212 | Cutter— $1\frac{1}{4}''$ dia. | 15° x 75° |
| 607 | Cutter— $1\frac{1}{2}''$ dia. | 30° |
| 608 | Cutter— $1\frac{1}{2}''$ dia. | 45° |
| 216 | Cutter— $1\frac{1}{2}''$ dia. | 75° |
| 623 | Cutter— $1\frac{3}{4}''$ dia. | 15° x 30° |
| 635 | Cutter— $1\frac{3}{4}''$ dia. | 15° x 45° |

| | |
|----------|-------------------------|
| 100-5,0 | Solid Pilot—5,0mm dia. |
| 100-5,02 | Solid Pilot—5,02mm dia. |
| 100-6,0 | Solid Pilot—6,0mm dia. |
| 100-6,02 | Solid Pilot—6,02mm dia. |
| 140-5,0 | Solid Pilot—5,0mm dia. |
| 140-5,02 | Solid Pilot—5,02mm dia. |
| 140-6,0 | Solid Pilot—6,0mm dia. |
| 140-6,02 | Solid Pilot—6,02mm dia. |
| 140-6,98 | Solid Pilot—6,98mm dia. |
| 140-7,0 | Solid Pilot—7,0mm dia. |
| 140-7,98 | Solid Pilot—7,98mm dia. |
| 140-8,0 | Solid Pilot—8,0mm dia. |

| | |
|---------|---|
| TW505 | T-Wrench |
| TW503-1 | Adaptor, $\frac{1}{8}''$ to $\frac{3}{8}''$ |
| CA497 | Case |
| KACC246 | Accessories Kit |

No. KM 2350 for Ducati*

| | | |
|-----|-------------------------------|-----|
| 270 | Cutter— $1\frac{1}{4}''$ dia. | 60° |
| 602 | Cutter— $1\frac{1}{4}''$ dia. | 31° |
| 608 | Cutter— $1\frac{1}{4}''$ dia. | 45° |
| 205 | Cutter— $1\frac{1}{2}''$ dia. | 60° |
| 628 | Cutter— $1\frac{1}{2}''$ dia. | 31° |
| 620 | Cutter— $1\frac{1}{2}''$ dia. | 45° |

| | |
|----------|-------------------------|
| 140-7,0 | Solid Pilot—7,0mm dia. |
| 140-7,02 | Solid Pilot—7,02mm dia. |
| 140-7,98 | Solid Pilot—7,98mm dia. |
| 140-8,0 | Solid Pilot—8,0mm dia. |
| 140-8,02 | Solid Pilot—8,02mm dia. |

| | |
|---------|-----------------|
| TW505 | T-Wrench |
| CA497 | Case |
| KACC246 | Accessories Kit |

*Components suggested by manufacturer.
†Short Hub required for this Kit.

No. KM 2537 for Kawasaki*

| | | |
|-----|---------------------|-----------|
| 132 | Cutter— .830" dia. | 32° |
| 131 | Cutter— .850" dia. | 45° |
| 133 | Cutter— .874" dia. | 60° |
| 110 | Cutter— .975" dia. | 46° |
| 115 | Cutter— .975" dia. | 31° |
| 111 | Cutter— 1" dia. | 60° |
| 203 | Cutter— 1 1/4" dia. | 31° x 46° |
| 244 | Cutter— 1 1/4" dia. | 15° |
| 270 | Cutter— 1 1/4" dia. | 60° |
| 205 | Cutter— 1 1/2" dia. | 60° |
| 626 | Cutter— 1 1/2" dia. | 30° x 45° |

| | |
|----------|-------------------------|
| 100-4,0 | Solid Pilot—4,0mm dia. |
| 100-4,5 | Solid Pilot—4,5mm dia. |
| 100-5,0 | Solid Pilot—5,0mm dia. |
| 100-5,5 | Solid Pilot—5,5mm dia. |
| 100-5,52 | Solid Pilot—5,52mm dia. |
| 140-7,0 | Solid Pilot—7,0mm dia. |
| 140-7,02 | Solid Pilot—7,02mm dia. |
| 140-7,5 | Solid Pilot—7,5mm dia. |
| 140-7,52 | Solid Pilot—7,52mm dia. |
| 140-8,0 | Solid Pilot—8,0mm dia. |
| 140-8,02 | Solid Pilot—8,02mm dia. |

TW505 T-Wrench
 TW503-1 Adaptor 1/2" to 3/8"
 CA497 Case
 KACC246 Accessories Kit

No. KM 2508 for Suzuki*

| | | |
|-----|---------------------|-----------|
| 130 | Cutter— .816" dia. | 15° |
| 131 | Cutter— .850" dia. | 45° |
| 122 | Cutter— .975" dia. | 45° |
| 111 | Cutter— 1" dia. | 60° |
| 121 | Cutter— 1" dia. | 15° |
| 126 | Cutter— 1" dia. | 30° |
| 615 | Cutter— 1 3/8" dia. | 15° x 45° |
| 212 | Cutter— 1 1/2" dia. | 15° x 75° |
| 608 | Cutter— 1 1/4" dia. | 45° |
| 216 | Cutter— 1 1/2" dia. | 75° |
| 635 | Cutter— 1 1/2" dia. | 15° x 45° |

| | |
|----------|-------------------------|
| 100-4,0 | Solid Pilot—4,0mm dia. |
| 100-4,5 | Solid Pilot—4,5mm dia. |
| 100-5,0 | Solid Pilot—5,0mm dia. |
| 100-5,5 | Solid Pilot—5,5mm dia. |
| 100-5,52 | Solid Pilot—5,52mm dia. |
| 100-7,0 | Solid Pilot—7,0mm dia. |
| 140-5,0 | Solid Pilot—5,0mm dia. |
| 140-5,5 | Solid Pilot—5,5mm dia. |
| 140-6,98 | Solid Pilot—6,98mm dia. |
| 140-7,0 | Solid Pilot—7,0mm dia. |

TW505 T-Wrench
 TW503-1 Adaptor 1/2" to 3/8"
 CA497 Case
 KACC246 Accessories Kit

No. KM 2140 General All Terrain Vehicle Kit

| | | |
|-----|--------------------|-----|
| 122 | Cutter— .975" dia. | 45° |
| 123 | Cutter— .975" dia. | 31° |
| 111 | Cutter— 1" dia. | 60° |

| | |
|----------|-------------------------|
| 100-5,52 | Solid Pilot—5,52mm dia. |
| 100-6,0 | Solid Pilot—6,0mm dia. |
| 100-6,6 | Solid Pilot—6,6mm dia. |

TW513 T-Wrench
 CA303 Case
 KACC246 Accessories Kit

No. KM 2493 for Yamaha*

| | | |
|-----|---------------------|-----------|
| 131 | Cutter— .850" dia. | 45° |
| 138 | Cutter— .870" dia. | 20° |
| 133 | Cutter— .874" dia. | 60° |
| 122 | Cutter— .975" dia. | 45° |
| 123 | Cutter— .975" dia. | 31° |
| 127 | Cutter— .975" dia. | 20° |
| 111 | Cutter— 1" dia. | 60° |
| 203 | Cutter— 1 1/4" dia. | 31° x 46° |
| 205 | Cutter— 1 1/2" dia. | 60° |
| 642 | Cutter— 1 1/2" dia. | 31° x 46° |

| | |
|----------|-------------------------|
| 100-4,0 | Solid Pilot—4,0mm dia. |
| 100-4,48 | Solid Pilot—4,48mm dia. |
| 100-4,5 | Solid Pilot—4,5mm dia. |
| 100-5,0 | Solid Pilot—5,0mm dia. |
| 100-5,5 | Solid Pilot—5,5mm dia. |
| 100-6,0 | Solid Pilot—6,0mm dia. |
| 100-7,0 | Solid Pilot—7,0mm dia. |
| 140-7,0 | Solid Pilot—7,0mm dia. |
| 140-7,02 | Solid Pilot—7,02mm dia. |
| 140-8,0 | Solid Pilot—8,0mm dia. |
| 140-8,02 | Solid Pilot—8,02mm dia. |

TW505 T-Wrench
 TW503-1 Adaptor, 1/2" to 3/8"
 CA497 Case
 KACC246 Accessories Kit

No. KM 2487 for Honda*

| | | |
|-----|---------------------|-----------|
| 144 | Cutter— .758" dia. | 32° |
| 132 | Cutter— .830" dia. | 32° |
| 131 | Cutter— .850" dia. | 45° |
| 133 | Cutter— .874" dia. | 60° |
| 143 | Cutter— .925" dia. | 45° |
| 142 | Cutter— .925" dia. | 32° |
| 122 | Cutter— .975" dia. | 45° |
| 123 | Cutter— .975" dia. | 31° |
| 111 | Cutter— 1" dia. | 60° |
| 270 | Cutter— 1 1/4" dia. | 60° |
| 607 | Cutter— 1 1/2" dia. | 30° |
| 608 | Cutter— 1 1/2" dia. | 45° |
| 626 | Cutter— 1 1/2" dia. | 30° x 45° |

| | |
|----------|-------------------------|
| 100-3,8 | Solid Pilot—3,8mm dia. |
| 100-3,82 | Solid Pilot—3,82mm dia. |
| 100-4,0 | Solid Pilot—4,0mm dia. |
| 100-4,02 | Solid Pilot—4,02mm dia. |
| 100-4,5 | Solid Pilot—4,5mm dia. |
| 100-4,52 | Solid Pilot—4,52mm dia. |
| 100-4,55 | Solid Pilot—4,55mm dia. |
| 100-5,0 | Solid Pilot—5,0mm dia. |
| 100-5,02 | Solid Pilot—5,02mm dia. |
| 100-5,5 | Solid Pilot—5,5mm dia. |
| 100-5,52 | Solid Pilot—5,52mm dia. |
| 100-6,6 | Solid Pilot—6,6mm dia. |
| 140-5,0 | Solid Pilot—5,0mm dia. |
| 140-5,5 | Solid Pilot—5,5mm dia. |
| 140-6,0 | Solid Pilot—6,0mm dia. |
| 140-6,02 | Solid Pilot—6,02mm dia. |
| 140-6,6 | Solid Pilot—6,6mm dia. |
| 140-6,98 | Solid Pilot—6,98mm dia. |

TW505 T-Wrench
 TW503-1 Adaptor, 1/2" to 3/8"
 CA497 Case
 KACC246 Accessories Kit

No. KMU 460 Honda VTX Upgrade Kit*

| | | |
|-----|---------------------|-----------|
| 645 | Cutter— 1 1/2" dia. | 30° x 45° |
| 205 | Cutter— 1 1/2" dia. | 60° |

| | |
|----------|-------------------------|
| 140-8,0 | Solid Pilot—8,0mm dia. |
| 140-8,02 | Solid Pilot—8,02mm dia. |

*Components suggested by manufacturer.

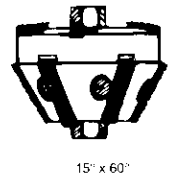
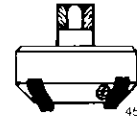
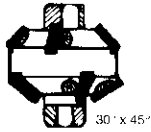

PARTS LIST

2004

STANDARD SERIES VALVE SEAT CUTTERS (for use with standard series pilots, .375" top)

| Cutter Head Dia. | Angles | No. of Blades | Part No. of Blades | Part Number | Cutter Head Dia. | Angles | No. of Blades | Part No. of Blades | Part Number | Cutter Head Dia. | Angles | No. of Blades | Part No. of Blades | Part Number | | | | | | |
|------------------|-----------|---------------|--------------------|-------------|------------------|-----------|---------------|--------------------|-------------|------------------|-----------|---------------|--------------------|--|-----------|------------------|-----------|-------|---------|-----|
| 28.6mm 1-1/8" | 15° | 3 | 250 | 243 | 38mm 1-1/2" | 0° | 3 | 251 | 720 | 44.5mm 1-3/4" | 31° x 46° | 5/5 | 251 | 642 | | | | | | |
| | 30° | 3 | 250 | 278 | | 11° x 45° | 3/3 | 251 | 239 | | 35° | 5 | 251 | 695 | | | | | | |
| | 30° | 3 | 253 | 299 | | 15° | 5 | 250 | 629 | | 37-1/2° | 5 | 251 | 698 | | | | | | |
| | 30° x 45° | 3/3 | 250 | 274 | | 15° x 30° | 3/5 | 250 | 623 | | 60° | 3 | 254 | 293 | | | | | | |
| | 45° | 3 | 250 | 268 | | 15° x 45° | 3/5 | 251 | 625 | | 60° | 5 | 254 | 644 | | | | | | |
| | 60° | 3 | 252 | 269 | | 15° x 46° | 3/5 | 251 | 621 | | 75° | 3 | 254 | 272 | | | | | | |
| 31.8mm 1-1/4" | 75° | 3 | 254 | 279 | 15° x 60° | 3/3 | 251/254 | 213 | 80° | 5 | 254 | 8044 | 50.8mm 2" | 55° | 5 | 251 | 17555 | | | |
| | 0° | 3 | 250 | 701 | 15° x 60° | 5/5 | 251/254 | 619 | 0° | 3 | 251 | 750 | | 15° | 5 | 251 | 686 | | | |
| | 15° | 3 | 250 | 244 | 15° x 70° | 3/3 | 251/254 | 297 | 15° x 45° | 3/5 | 251 | 659 | | 15° x 60° | 3/3 | 251/254 | 288 | | | |
| | 15° | 5 | 250 | 604 | 15° x 75° | 3/3 | 251/254 | 217 | 15° x 60° | 5/5 | 251/254 | 653 | | 15° x 75° | 5/5 | 251/254 | 654 | | | |
| | 15° x 31° | 3/5 | 250 | 603 | 15° x 75° | 5/5 | 251/254 | 624 | 25° | 5 | 251 | 689 | | 20° | 5 | 250 | 681 | | | |
| | 15° x 45° | 3/3 | 250 | 229 | 30° | 5 | 250 | 627 | 30° | 5 | 251 | 680 | | 30° | 5 | 251 | 680 | | | |
| | 15° x 46° | 3/3 | 250 | 204 | 30° x 45° | 3/3 | 251 | 234 | 30° x 45° | 5/5 | 251 | 660 | | 31° x 46° | 5/5 | 251 | 652 | | | |
| | 15° x 60° | 3/3 | 250/252 | 273 | 30° x 45° | 5/5 | 251 | 626 | 31° | 5 | 251 | 628 | | 36° | 5 | 251 | 683 | | | |
| | 15° x 75° | 3/3 | 250/254 | 212 | 31° | 5 | 251 | 628 | 31° x 46° | 5/5 | 251 | 690 | | 60° | 5 | 254 | 657 | | | |
| | 20° x 45° | 3/3 | 250 | 220 | 31° x 46° | 3/3 | 251 | 208 | 36° | 5 | 251 | 692 | | 70° | 5 | 254 | 684 | | | |
| | 25° | 5 | 250 | 606 | 31° x 46° | 5/5 | 251 | 622 | 43° x 52° | 5/5 | 251 | 691 | 80° | 7 | 254 | 8050 | | | | |
| | 30° | 5 | 250 | 607 | 35° | 5 | 251 | 690 | 45° | 5 | 251 | 620 | 55.5mm 2-3/16" | 20° | 5 | 251 | 685 | | | |
| | 30° x 45° | 3/3 | 250 | 230 | 36° | 5 | 251 | 692 | 46° | 3 | 251 | 275 | | 57.2mm 2-1/4" | 0° | 3 | 251 | 760 | | |
| | 31° | 5 | 250 | 602 | 46° | 3 | 254 | 205 | 46° | 3 | 254 | 205 | | | 15° x 46° | 5/9 | 251 | 664 | | |
| | 31° x 46° | 3/3 | 250 | 203 | 65° | 3 | 254 | 219 | 65° | 3 | 254 | 219 | | | 15° x 60° | 5/5 | 251/254 | 666 | | |
| | 45° | 5 | 250 | 608 | 70° | 3 | 254 | 271 | 70° | 3 | 254 | 271 | | | 30° x 45° | 7/7 | 251 | 665 | | |
| | 46° | 3 | 250 | 285 | 75° | 3 | 254 | 216 | 75° | 3 | 254 | 216 | | | 31° x 46° | 7/7 | 251 | 662 | | |
| | 46° | 5 | 250 | 609 | 80° | 5 | 254 | 8038 | 80° | 5 | 254 | 8038 | | | 55° | 5 | 251 | 22555 | | |
| | 60° | 3 | 252 | 270 | 41.3mm 1-5/8" | 15° x 45° | 5/5 | 251 | 635 | 44.5mm 1-3/4" | 15° | 5 | | 251 | 676 | 63.5mm 2-1/2" | 15° x 60° | 5/5 | 251/254 | 674 |
| | 65° | 3 | 254 | 605 | | 15° x 46° | 3/5 | 251 | 631 | | 15° x 45° | 3/5 | | 251 | 646 | | 30° x 45° | 7/7 | 251 | 677 |
| 70° | 3 | 252 | 222 | 20° x 45° | | 5/5 | 251 | 633 | 15° x 46° | | 3/5 | 251 | | 641 | 31° x 46° | | 7/7 | 251 | 672 | |
| 75° | 3 | 254 | 206 | 30° x 45° | | 3/3 | 251 | 237 | 15° x 60° | | 3/3 | 251/254 | 292 | 60° | 5 | | 254 | 675 | | |
| 80° | 5 | 254 | 8031 | 30° x 45° | | 5/5 | 251 | 636 | 15° x 60° | | 5/5 | 251/254 | 643 | 55° | 5 | | 251 | 25055 | | |
| | | | | 31° x 46° | | 5/5 | 251 | 632 | 15° x 75° | | 5/5 | 251/254 | 697 | SPECIAL ORDER CUTTERS CAN BE MADE TO ANY ANGLE / DIAMETER YOU MAY REQUIRE (UP TO 6"). CALL FOR QUOTATION. | | | | | | |
| | | | | 45° | | 5 | 251 | 634 | 25° | 5 | 251 | 696 | | | | | | | | |
| | | | | | | | | | 30° | 5 | 250 | 647 | | | | | | | | |
| | | | | | | | | | 30° x 45° | 5/5 | 251 | 645 | | | | | | | | |
| | | | | | | | | | 31° | 5 | 251 | 649 | | | | | | | | |

Large cutters up to 150mm diameter (6") made to special order











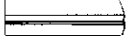

SMALL SERIES VALVE SEAT CUTTERS (for use with small series pilots, .297" top)

| Cutter Diameter | Angle | Number of Blades | Part Number | Cutter Head Dia. | Angles | No. of Blades | Part No. of Blades | Part Number | Cutter Head Dia. | Angles | No. of Blades | Part No. of Blades | Part Number | | |
|-----------------|--------|------------------|-------------|------------------|-----------------|---------------|--------------------|-------------|------------------|-------------------|---------------|--------------------|-------------|-----|--|
| .760" | 19.3mm | 15° | 3** | 134 | 24.8mm .975" | 20° | 3 | 253 | 127 | 28.6mm 1-1/8" | 31° x 46° | 3/3 | 253 | 103 | |
| .816" | 20.7mm | 15° | 3** | 130 | | 31° | 3 | 250 | 115 | | | | | | |
| .870" | 22.1mm | 20° | 3** | 138 | | 31° | 3 | 253 | 123 | | | | | | |
| .758" | 19.3mm | 32° | 3** | 144 | | 45° | 3 | 253 | 122 | | | | | | |
| .830" | 21.1mm | 32° | 3** | 132 | | 46° | 3 | 253 | 110 | | | | | | |
| .925" | 23.5mm | 32° | 3** | 142 | 25.4mm 1" | 15° | 3 | 553 | 120 | 31.8mm 1-1/4" | 30° x 45° | 3/3 | 250 | 128 | |
| .830" | 21.1mm | 45° | 3** | 135 | | 15° | 3 | 355 | 119 | | 60° | 3 | 252 | 114 | |
| .850" | 21.6mm | 45° | 3** | 131 | | 15° | 3 | 253 | 121 | 33.3mm 1-5/16" | 15° x 60° | 3/3 | 251/254 | 124 | |
| .925" | 23.5mm | 45° | 3** | 143 | | 30° | 3 | 250 | 126 | | 31° x 46° | 3/3 | 251 | 102 | |
| .874" | 22.2mm | 60° | 3** | 133 | | 60° | 3 | 252 | 111 | | | | | | |
| | | | | | | 75° | 3 | 254 | 125 | | | | | | |

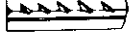

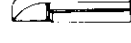
**Sold as complete unit only — blades nonreplaceable

TUNGSTEN CARBIDE REPLACEMENT BLADES

FOR VALVE SEAT CUTTERS

| Part No. | Length | Description |
|--|---------------|---------------------------------------|
|  152 | 1/2" (12.7mm) | Non-serrated blade correction cutters |
|  154 | 3/4" (19mm) | Non-serrated blade correction cutters |
|  250 | 3/8" (9.5mm) | 0° thru 46° seat cutters |
|  250 LC | 3/8" (9.5mm) | For use on hard seats only |
|  251 | 1/2" (12.7mm) | 0° thru 46° seat cutters |
|  251 LC | 1/2" (12.7mm) | For use on hard seats only |
|  252 | 1/2" (12.7mm) | 60° thru 80° correction cutters |
|  253 | 5/16" (7.9mm) | 0° thru 46° seat cutters |
|  254 | 3/4" (19mm) | 60° thru 80° correction cutters |
|  352 | 1/2" (12.7mm) | Radius blade — blending purpose |
|  354 | 3/4" (19mm) | Radius blade — blending purpose |
|  355 | 3/8" (9.5mm) | Radius blade — blending purpose |
|  353 | 5/16" (7.9mm) | Honda power products (stepped) |
|  553 | 5/16" (7.9mm) | Suzuki motorcycles (short-angled) |

FOR VALVE REFACERS

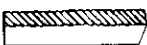
| | | |
|--|-------------|--|
|  VFR 72 | — — | For VFR-1000, standard insert |
|  VFR 74 | — — | For VFR-1000, titanium/stainless valves |
|  VFR 75 | — — | For VFR-1000, very hard stellite valves |
|  HVR CARB | 3/4" (19mm) | For "Gizmatic" and HVR manual valve refacers |

STANDARD SERIES SOLID PILOTS — .375" TOP

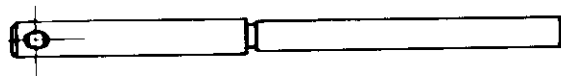

Note: Neway stocks many special sized pilots which do not appear on the parts list. Please call to check availability.

FRACTIONAL SIZES

| Part No. | Overall Length | Part No. | Overall Length |
|--|-----------------|---|-----------------|
| 140-1/4" Std. (Also -3, -2, -1, +1, +2, +3, +4) | .152mm (6") | 140-3/8" Std. (Also -5, -4, -3, -2, -1, +1, +2, +3, +4, +5, +6, +7, +13, +14, +15, +16) | .178mm (7") |
| 140-9/32" Std. (Also -1, +1, +2, +3, +4, +5) | .152mm (6") | 140-13/32" Std. (Also -1, +1, +2, +3, +4, +5, +8, +9, +10, +11, +12) | .178mm (7") |
| 140-19/64" Std. (Also -1, +1, +2, +3, +4, +5) | .152mm (6") | 140-7/16" Std. (Also -3, -2, -1, +1, +2, +3, +4, +5) | .178mm (7") |
| 140-5/16" Std. (Also -4, -3, -2, -1, +1, +2, +3, +4, +5, +14, +15, +16) | .152mm (6") | 140-29/64" Std. (Also -3, -2, -1, +1, +2, +3, +4, +5, +6, +7, +8) | .197mm (7-3/4") |
| 140-21/64" Std. (Also -1, +1) | .165mm (6-1/2") | 140-1/2" Std. (Also -4, -3, -2, -1, +1, +2, +3, +4, +5) | .197mm (7-3/4") |
| 140-11/32" Std. (Also -4, -3, -2, -1, +1, +2, +3, +4, +5, +14, +15, +16) | .165mm (6-1/2") | | |

METRIC SIZES

| Part No. | Overall Length | Part No. | Overall Length |
|---|----------------|---|-----------------|
| 140-4.5mm (Also 4.52mm) | .152mm (6") | 140-8.0mm (Also 7.98mm, 8.02mm, 8.10mm, 8.20mm) | .152mm (6) |
| 140-5.0mm (Also 4.98mm, 5.02mm) | .152mm (6") | 140-8.5mm (Also 8.48mm, 8.52mm) | .165mm (6-1/2") |
| 140-5.5mm (Also 5.48mm, 5.52mm, 5.55mm) | .152mm (6") | 140-9.0mm (Also 8.98mm, 9.02mm) | .165mm (6-1/2") |
| 140-6.0mm (Also 5.98mm, 6.02mm) | .152mm (6") | 140-9.5mm (Also 9.48mm, 9.52mm) | .178mm (7") |
| 140-6.6mm (Also 6.58mm, 6.62mm) | .152mm (6") | 140-10.0mm (Also 9.98mm, 10.02mm) | .178mm (7") |
| 140-7.0mm (Also 6.98mm, 7.02mm, 7.10mm, 7.20mm) | .152mm (6") | 140-11.0mm (Also 10.98mm, 11.02mm) | .197mm (7-3/4") |
| 140-7.5mm (Also 7.48mm, 7.52mm) | .152mm (6") | 140-12.0mm (Also 11.98mm, 12.02mm) | .197mm (7-3/4") |

STANDARD SERIES EXPANDABLE PILOTS — .375" TOP



FRACTIONAL SIZES

| Part No. | Collet Length | Overall | Part No. | Collet Length | Overall |
|------------------|----------------|----------------|------------------|----------------|----------------|
| 150-1/4" | .38mm (1-1/2") | 152mm (6") | 200-5/16" | .44mm (1-3/4") | 197mm (7-3/4") |
| 150-9/32" | .38mm (1-1/2") | 159mm (6-1/4") | 200-11/32" | .44mm (1-3/4") | 197mm (7-3/4") |
| 150-5/16" | .38mm (1-1/2") | 165mm (6-1/2") | 200-3/8" | .44mm (1-3/4") | 197mm (7-3/4") |
| 150-11/32" | .38mm (1-1/2") | 165mm (6-1/2") | 200-25/64" | .50.8mm (2") | 203mm (8") |
| 150-3/8" | .38mm (1-1/2") | 178mm (7") | 200-13/32" | .50.8mm (2") | 203mm (8") |
| 150-25/64" | .38mm (1-1/2") | 178mm (7") | 200-7/16" | .50.8mm (2") | 203mm (8") |
| 150-13/32" | .38mm (1-1/2") | 178mm (7") | 200-1/2" | .50.8mm (2") | 203mm (8") |
| 150-7/16" | .38mm (1-1/2") | 178mm (7") | | | |
| 150-1/2" | .38mm (1-1/2") | 178mm (7") | | | |

METRIC SIZES

| Part No. | Collet Length | Overall | Part No. | Collet Length | Overall |
|------------------|----------------|----------------|------------------|----------------|----------------|
| 150-5.5mm | .29mm (1-1/8") | 152mm (6") | 200-8mm | .44mm (1-3/4") | 197mm (7-3/4") |
| 150-6mm | .29mm (1-1/8") | 152mm (6") | 200-8.5mm | .44mm (1-3/4") | 197mm (7-3/4") |
| 150-6.5mm | .29mm (1-1/8") | 152mm (6") | 200-9mm | .44mm (1-3/4") | 197mm (7-3/4") |
| 150-7mm | .38mm (1-1/2") | 159mm (6-1/4") | 200-9.5mm | .44mm (1-3/4") | 197mm (7-3/4") |
| 150-7.5mm | .38mm (1-1/2") | 159mm (6-1/4") | 200-10mm | .50.8mm (2") | 203mm (8") |
| 150-8mm | .38mm (1-1/2") | 165mm (6-1/2") | 200-10.5mm | .50.8mm (2") | 203mm (8") |
| 150-8.5mm | .38mm (1-1/2") | 165mm (6-1/2") | 200-11mm | .50.8mm (2") | 203mm (8") |
| 150-9mm | .38mm (1-1/2") | 178mm (7") | 200-11.5mm | .50.8mm (2") | 203mm (8") |
| 150-9.5mm | .38mm (1-1/2") | 178mm (7") | 200-12mm | .50.8mm (2") | 203mm (8") |
| 150-10mm | .38mm (1-1/2") | 178mm (7") | 200-12.5mm | .50.8mm (2") | 203mm (8") |
| 150-10.5mm | .38mm (1-1/2") | 178mm (7") | 200-13mm | .50.8mm (2") | 203mm (8") |
| 150-11mm | .38mm (1-1/2") | 178mm (7") | | | |
| 150-11.5mm | .38mm (1-1/2") | 178mm (7") | | | |
| 150-12mm | .38mm (1-1/2") | 178mm (7") | | | |
| 150-12.5mm | .38mm (1-1/2") | 178mm (7") | | | |

SMALL SERIES SOLID PILOTS — .297" TOP (FOR USE WITH SMALL SERIES CUTTERS)

FRACTIONAL SIZES

| Part No. | Overall Length | Part No. | Overall Length |
|------------------------------|----------------|---------------------------|----------------|
| 100-1/4" (Also -1, +1) | 114mm (4-1/2") | 100-5/16" (Also +1) | 114mm (4-1/2") |
| 100-9/32" | 114mm (4-1/2") | 100-11/32" | 114mm (4-1/2") |

METRIC SIZES

| Part No. | Overall Length | Part No. | Overall Length |
|---|----------------|---|----------------|
| 100-3.8mm (Also 3.82mm) | .95mm (3-3/4") | 100-5.58mm (short) | .76mm (3") |
| 100-4.0mm* (Also 3.98mm, 4.02mm*, 4.05mm) | .95mm (3-3/4") | 100-6.0mm (Also 5.98mm, 6.02mm, 6.05mm) | 114mm (4-1/2") |
| 100-4.5mm* (Also 4.48mm, 4.52mm*, 4.55mm) | 114mm (4-1/2") | 100-6.5mm | 133mm (5-1/4") |
| 100-4.8mm | .89mm (3-1/2") | 100-6.6mm (Also 6.58mm, 6.62mm) | 133mm (5-1/4") |
| 100-5.0mm (Also 4.98mm, 5.02mm) | 114mm (4-1/2") | 100-7.0mm (Also 7.02mm, 7.05mm) | 114mm (4-1/2") |
| 100-5.5mm (Also 5.48mm, 5.52mm) | 114mm (4-1/2") | 100-7.5mm | 114mm (4-1/2") |
| 100-5.5mm (short) | .76mm (3") | 100-8.0mm | 114mm (4-1/2") |
| 100-5.52mm (short) | .76mm (3") | 100-9.0mm | 114mm (4-1/2") |
| 100-5.55mm (short) | .76mm (3") | | |

* Carbide pilots also available in these sizes

SMALL SERIES EXPANDABLE PILOTS — .297" TOP (FOR USE WITH SMALL SERIES CUTTERS)

FRACTIONAL SIZES

| Part No. | Collet Length | Overall |
|------------------|----------------|----------------|
| 120-1/4" | .29mm (1-1/8") | 133mm (5-1/4") |
| 120-9/32" | .38mm (1-1/2") | 159mm (6-1/4") |
| 120-5/16" | .38mm (1-1/2") | 159mm (6-1/4") |
| 120-11/32" | .38mm (1-1/2") | 165mm (6-1/2") |

METRIC SIZES

| Part No. | Collet Length | Overall |
|-----------------|----------------|----------------|
| 120-5.5mm | .29mm (1-1/8") | 133mm (5-1/4") |
| 120-6mm | .29mm (1-1/8") | 133mm (5-1/4") |
| 120-6.5mm | .29mm (1-1/8") | 133mm (5-1/4") |
| 120-7mm | .38mm (1-1/2") | 159mm (6-1/4") |
| 120-7.5mm | .38mm (1-1/2") | 159mm (6-1/4") |
| 120-8mm | .38mm (1-1/2") | 159mm (6-1/4") |
| 120-8.5mm | .38mm (1-1/2") | 165mm (6-1/2") |

TOOL CASES

| Part No. | Capacity | Case Dimensions |
|-------------|------------|---------------------------------|
| CA 303 Case | 3 Cutters | 7-1/2" x 10" (19cm x 25cm) |
| CA 160 Case | 6 Cutters | 8" x 12" (20cm x 30.5cm) |
| CA 497 Case | 11 Cutters | 12-1/2" x 15-1/2" (32cm x 39cm) |

For Small Series Only



CA 303



CA 160

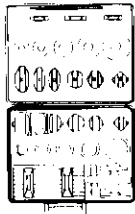

CA 497

WRENCHES

| Part No. | Description |
|-----------|---|
| TWEZ | Easy-Turn Wrench (see page 7) |
| TW 503* | 1/2" Hex metal T-wrench (for standard series cutters) |
| TW 503-1 | Adaptor 1/2" to 3/8" (for small series cutters) |
| TW 503-4 | 503 Extension 4-1/4" (108mm) tube only |
| TW 503-8 | 503 Extension 8" (203mm) tube only |
| TW 503-10 | 503 Extension 10" (254mm) tube only |
| TW 503-12 | 503 Extension 12" (305mm) tube only |
| TW 505 | T-wrench, 1/2" hex, nylon fiber (for standard series cutters) |
| TW 513 | T-wrench, 3/8" hex, nylon fiber (for small series cutters) |



TW 503

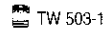

TW 503-1

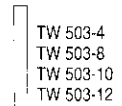

TW 503-4
TW 503-8
TW 503-10
TW 503-12

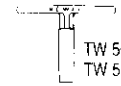

TW 505
TW 513

*T-Wrench consists of two pieces — handle and tube.

MISCELLANEOUS SEAT CUTTER PARTS

| Part No. | Description |
|----------|--|
| HK 564 | 5/64" Hex Driver |
| HK 332 | 3/32" Hex Key |
| PPP 245 | Pilot Puller Pin |
| S 260 | 5-40 Flat Head Screw |
| S 262 | 10-32 Set Screw |
| W 265 | Wedge, for heads over 25.4mm (1") diameter |
| W 266 | Wedge, for 25.4mm (1") diameter heads |
| CB 267 | Cleaning Brush |
| KACC 246 | ACCESSORIES KIT, includes: HK 564 5/64" Hex Driver HK 332 3/32" Hex Key PPP 245 Pilot Puller Pin CB 267 Cleaning Brush |
| KACC 100 | REPAIR KIT, includes: 12 W 265 Wedges 36 S 260 Screws 1 HK 564 5/64" Hex Driver 1 CB 267 Cleaning Brush |

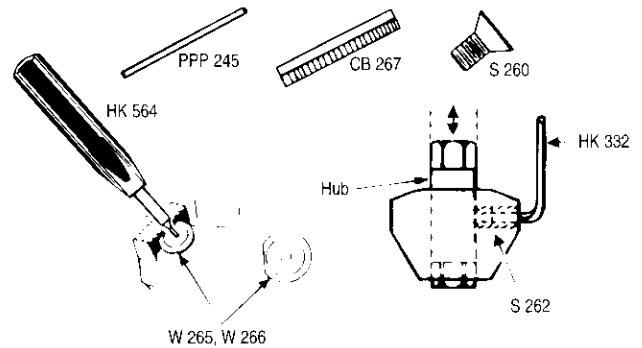

TECHNICAL INFORMATION CUTTERS

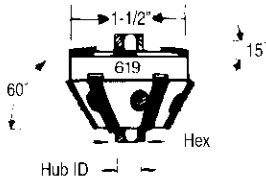

| Hub Hex Size | Hub ID |
|--------------|--------|
| 3/8" | .297" |
| 1/2" | .375" |
| 3/4" | .572" |

Application

Small Series — designed for use on small seats.

Standard Series — designed for use on most valve seats up to 2-1/2".

4000 Series — designed for use on large engines with valve guides exceeding 1/2" (12.7mm) in diameter and seats larger than 2-1/4" (57mm) in diameter. Used with .572 or 9/16" pilots.

Cutters of various angles and diameters up to 6" (152mm) quoted on request.

SOLID PILOTS

Solid pilot diameters are measured at center of taper (taper .0007"/inch). See examples at right.

Top Dia.

| |
|-------|
| .297" |
| .375" |

Application

Small Series (100) — for use with small series cutters only.
Standard Series (140) — for use with standard series cutters only.

Part No.

| |
|--------------|
| 140-3/8 Std. |
| 140-3/8-1 |

Diameter at Center of Taper

| |
|----------------------------|
| .375" (3/8") diameter |
| .374 (3/8"-.001") diameter |

140-7mm .275" (7mm) diameter

140-7.02mm

.276" (7.02mm) diameter

EXPANDABLE PILOTS

Top Dia.

| |
|-------|
| .297" |
| .375" |
| .375" |

Application

Small Series (120) — for use with small series cutters only.
Standard Series (150) — for use with standard series cutters only. Fits the majority of valve guides.
Standard Series (200) — for use with standard series cutters only. Fits heads with extra long valve guides.

Note: Expandable pilot diameters are measured at center of collet which is .003" under the stated diameter.

Collets expand a total of .020" (0.5mm) from .003" (0.1mm) under stated diameter to .017" (0.4mm) over stated diameter.

EXPANDABLE PILOTS — SPARE PARTS



Note: Orders for expandable pilot spare parts **MUST** include **PILOT PART NUMBER, SUFFIX, and DESCRIPTION.**

*Spacer available only for 150-8mm (5/16") expandable pilot. Used on VW Rabbit or any engine with valve guides less than 1-1/2" (38mm) long.

POWER UNIT PARTS

| REPLACEMENT PARTS LIST | | |
|------------------------|-------------|-------------------------------------|
| Key No. | Part No. | Description |
| 1. | * | 1/4-20 Hex Nut |
| 2. | PU 042315 | Motor Mount Handle |
| 3. | PU 042310 | Motor Mount Bracket |
| 4. | PU 1703 | Trolley Complete |
| 5. | PU 1801 | Motor & Control Box Assembly |
| | PU 1801-230 | Motor & Control Box Assembly — 230V |
| 6. | PU 042501 | Foot Switch (1800 Motor) |
| | PU 0425010 | Foot Switch (1700 Motor) |
| 7. | PU 042134 | Nylon Washer |
| 8. | * | 3/8-16 Hex Nut |
| 9. | PU 42136 | Wheel Assembly |
| 10. | * | 3/8 ID Washer |
| 11. | * | 3/8-16 x 1" Hex Bolt |

*Obtain locally

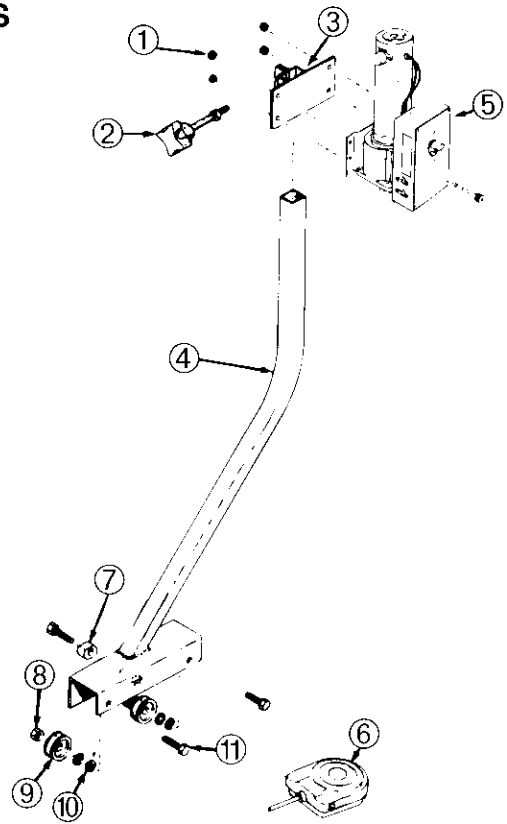

PU 1517 TRANSMISSION FOR POWER UNITS

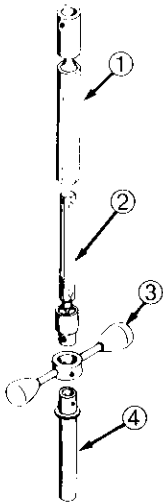

| REPLACEMENT PARTS BY SUB-ASSEMBLIES | | |
|-------------------------------------|-----------|-------------------------------------|
| Key No. | Part No. | Description |
| 1. | PU 043044 | Long Slide Tube |
| | PU 043045 | Short Slide Tube |
| 2. | PU 043046 | Long Hexed Slide |
| | PU 043047 | Short Hexed Slide |
| 3. | PU 043063 | Handle Assembly |
| 4. | PU 043067 | Transmission Wrench — 1/2" Standard |
| | PU 043069 | Transmission Wrench — 3/4" Special |

Note: Sub-assemblies may not be interchangeable with older style transmissions.

POWER UNIT ACCESSORIES

HEAD STANDS

Engine heads of any shape can be set quickly onto a pair of these welded steel head stands.

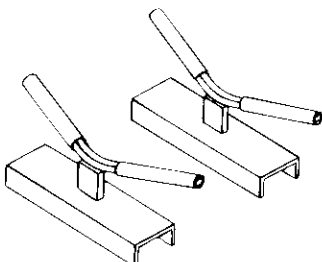

PU 1705 (sold as shown)

TRACK

Track is included with all power units in standard lengths of 4'. Special lengths are available upon request.

VFR-1000 VALVE REFAKER PARTS

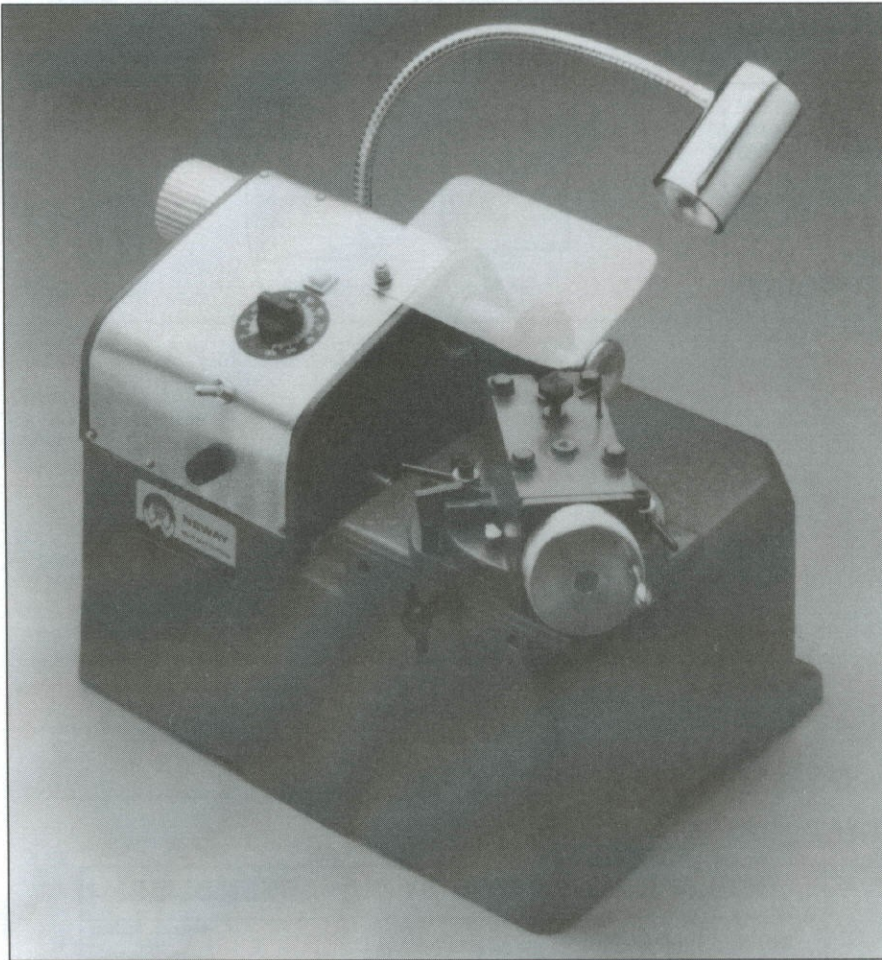

VFR-1000 COLLETS

Part No.

| | | |
|----------|-------|------------------|
| VFRC40 | | .4.0mm |
| VFRC50 | | .5.0mm |
| VFRC55 | | .5.5mm - 7/32" |
| VFRC60 | | .6.0mm |
| VFRC65 | | .6.5mm - 1/4" |
| VFRC66 | | .6.6mm |
| VFRC70 | | .7.0mm |
| VFRC932 | | .9/32" |
| VFRC80 | | .8.0mm - 5/16" |
| VFRC85 | | .8.5mm |
| VFRC1132 | | .11/32" |
| VFRC90 | | .9.0mm |
| VFRC95 | | .9.5mm - 3/8" |
| VFRC100 | | .10.0mm |
| VFRC105 | | .10.5mm - 13/32" |
| VFRC110 | | .11.0mm - 7/16" |
| VFRC115 | | .11.5mm |
| VFRC120 | | .12.0mm |
| VFRC125 | | .12.5mm |
| VFRC12 | | .1/2" |

VFR-1000 PARTS

| | | |
|----------|-------|------------------------------|
| VFR DISC | | Sanding discs (4/pkg.) |
| VFR 72 | | Carbide insert |
| VFR 74 | | Carbide (titanium/stainless) |
| VFR 75 | | Carbide (diesel) |
| VFR FUSE | | .4 Amp fuse |
| VFR BULB | | .25W R14 Bulb |

Valve Concentricity Gauge

Part Number CG

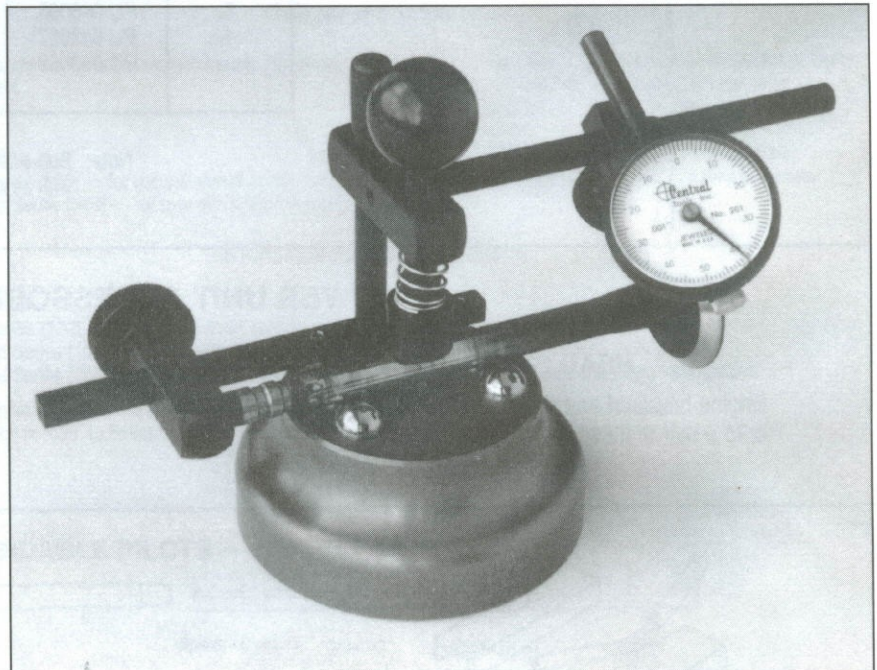

"GIZMATIC" VALVE REFACER PARTS

Part No.

GIZMATIC-3 "Gizmatic" Valve Refacer
HVR CARB Carbide Blade
HK 5645/64" Hex Driver
S260 Screw
W265 Wedge
CB267 Cleaning Brush

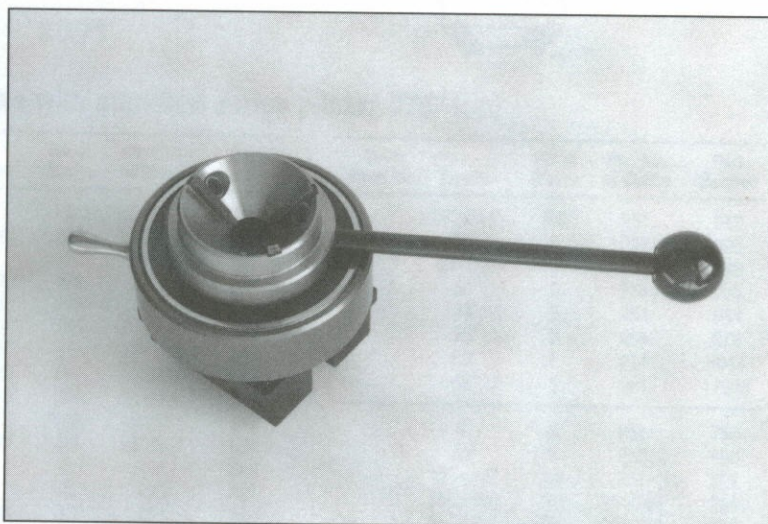

EASY-TURN WRENCH

Part No.

TWEZ Easy-Turn Wrench (includes TW503-1 Adaptor)
TW503-1 Adaptor, 1/2" to 3/8" for Small Series Cutters

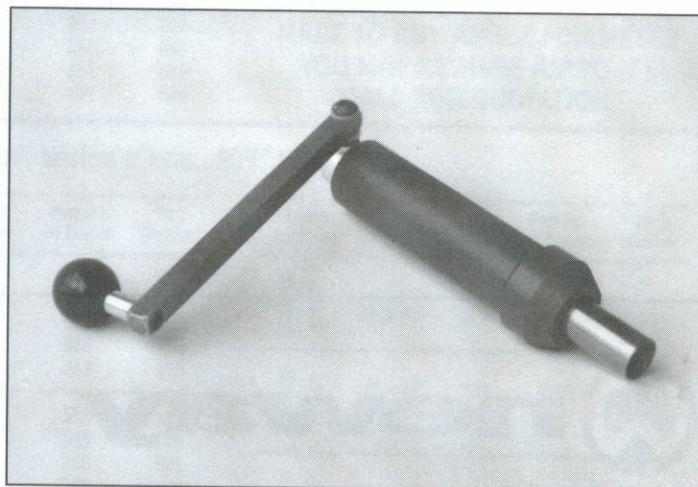
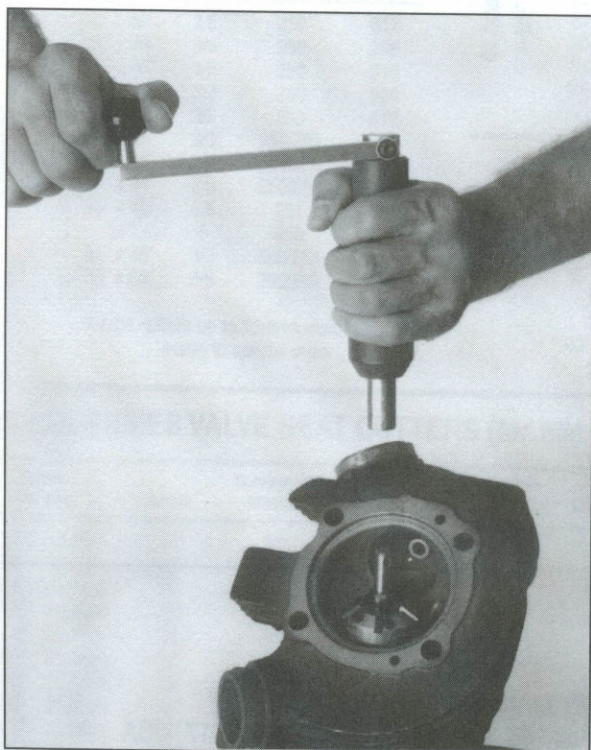



**USER PRICE LIST
EFFECTIVE JANUARY 1, 2003**

| Part No. | Description | Price |
|-------------------------------|---|------------|
| VALVE SEAT CUTTER | | |
| SHOP PACKAGES AND KITS | | |
| KSP 4583 | Heavy Duty Package, includes Pilots | \$ 4669.95 |
| KSP 4523 | Rebuilder Shop Package, includes Pilots | 4300.25 |
| KSP 4222 | Rebuilder Shop Package | 2654.75 |
| KA 475 | Rebuilder Kit..... | 1543.75 |
| KSP 4922 | Jobber Shop Package, includes Pilots | 3102.75 |
| KSP 4622 | Jobber Shop Package..... | 2386.75 |
| KA 462 | Jobber Kit | 1275.75 |
| KSP 5512 | Economy Shop Package, includes Pilots | 2295.00 |
| KSP 5211 | Economy Shop Package..... | 1871.50 |
| KA 436 | Economy Automotive Kit | 809.50 |
| KA 1500 | Small Block Chevy/Ford Kit | 931.75 |
| PILOT PACKAGES | | |
| KP 357 | Metric Solid Pilot Kit (33 Pilots) | \$ 661.50 |
| KP 369 | Metric Solid Pilot Kit (15 Pilots) | 292.50 |
| KPE 358 | Metric Expandable Pilot Kit (10 Pilots) | 355.00 |
| KP 365 | Fractional Solid Pilot Kit (44 Pilots) | 984.00 |
| KP 360 | Fractional Solid Pilot Kit (21 Pilots) | 423.50 |
| KPE 354 | Fractional Expandable Pilot Kit (6 Pilots) | 213.00 |
| KPE 353 | Fractional Expandable Pilot Kit (4 Pilots) | 142.00 |
| IMPORT AUTOMOTIVE KITS | | |
| KA 1422 | General Import Auto Kit w/Solid Pilots | \$ 1583.75 |
| KA 1427 | General Import Auto Kit w/Expandable Pilots | 1335.75 |
| KA 1220 | BMW Auto Kit | 888.75 |
| KA 1802 | Honda Auto Kit | 733.00 |
| KA 1551 | Hyundai Auto Kit | 729.00 |
| KA 1350 | Land Rover Auto Kit | 251.50 |
| KA 1307 | Mazda Auto Kit | 647.25 |
| KA 1214 | Mercedes-Benz Auto Kit | 762.50 |
| KA 1255 | Mitsubishi Auto Kit | 680.50 |
| KA 1275 | Nissan Auto Kit | 874.25 |
| KA 1408 | Porsche Auto Kit | 992.75 |
| KA 1320 | Saab Auto Kit | 571.50 |
| KA 1456 | Subaru Auto Kit | 518.00 |
| KA 1336 | Toyota Auto Kit | 784.75 |
| KA 1607 | Volkswagen/Audi Auto Kit | 691.75 |
| KA 1232 | Volvo Auto Kit | 556.50 |
| MOTORCYCLE KITS | | |
| KM 2573 | General Motorcycle Kit | \$ 1712.50 |
| KM 2563 | General Japanese Motorcycle Kit | 1179.50 |
| KM 2140 | All Terrain Vehicles (ATV) Kit | 239.00 |
| KM 2299 | BMW Motorcycle Kit | 1043.00 |
| KM 2350 | Ducati Motorcycle Kit | 592.25 |
| KM 2450 | Harley Davidson Motorcycle Kit | 833.50 |
| KMU 470 | Harley Davidson V-Rod Upgrade Kit | 174.50 |
| KM 2487 | Honda Motorcycle Kit | 1290.00 |
| KMU 460 | Honda VTX Upgrade Kit | 261.00 |
| KM 2537 | Kawasaki Motorcycle Kit | 1033.50 |
| KM 2508 | Suzuki Motorcycle Kit | 1098.00 |
| KM 2493 | Yamaha Motorcycle Kit | 965.50 |

| Part No. | Description | Price |
|--|--|------------|
| POWER UNITS | | |
| PU 1800 | Variable Speed Power Unit (115 volt)..... | \$ 995.00 |
| | Includes motor, trolley, 1517-A or B transmission, foot switch, 4 ft. track | |
| PU 1800-230 | Variable Speed Power Unit (230 volt) | 995.00 |
| | Includes motor, trolley, 1517-A or B transmission, foot switch, 4 ft. track | |
| VALVE FACE RECONDITIONING EQUIPMENT | | |
| MOTORIZED | | |
| VFR-1000 (115 volt)..... | | \$ 1995.00 |
| VFR-1000-230 (230 volt) | | 2050.00 |
| MANUALLY OPERATED | | |
| Gizmatic | | \$ 315.00 |
| ACCESSORIES | | |
| CG | Valve Concentricity Gauge | \$ 135.00 |
| CGVS | Valve Seat Dial Indicator | 109.50 |
| TUNGSTEN CARBIDE BLADES | | |
| TC 152 | 1/2" (12,7mm) Non-Serrated Blade | \$ 7.75 |
| TC 154 | 3/4" (19mm) Non-Serrated Blade | 7.95 |
| TC 250 | 3/8" (9,5mm) 15" thru 46" Seat Cutters | 7.75 |
| TC 250 LC | For use on hard seats only | 7.75 |
| TC 251 | 1/2" (12,7mm) 15" thru 46" Seat Cutters | 7.95 |
| TC 251 LC | For use on hard seats only | 7.95 |
| TC 252 | 1/2" (12,7mm) 60" thru 75" Correction Cutters | 7.75 |
| TC 253 | 5/16" (7,9mm) 15" thru 46" Seat Cutters | 7.75 |
| TC 254 | 3/4" (19mm) 60" thru 75" Correction Cutters | 7.95 |
| TC 352 | 1/2" (12,7mm) Radius Blade | 15.00 |
| TC 354 | 3/4" (19mm) Radius Blade | 15.00 |
| TC 355 | 3/8" (9,5mm) Radius Blade | 15.00 |
| TC 353 | 5/16" (7,9mm) Honda Power Products (Stepped) | 11.00 |
| TC 553 | 5/16" (7,9mm) Suzuki Motorcycles (Short-Angled) | 11.00 |
| HVRCARB | 3/4" (19mm) For Gizmatic and HVR only | 7.95 |
| VFR 72 | VFR Carbide for Standard Valves | 7.95 |
| VFR 74 | VFR Carbide for Titanium/Stainless Valves | 7.95 |
| VFR 75 | VFR Carbide for Stellite/Very Hard Valves | 7.95 |
| TCSR 9 | For SRC 31 Cutter Only (9mm) | 12.00 |
| TCSR 10 | For SRC 34 Cutter Only (10mm) | 12.00 |
| TCSR 12 | For SRC 37 & Over Cutters (12mm) | 12.00 |

NEWAY PRICE LIST

VALVE SEAT CUTTERS

| Part No. | Cutter Head Diameter | | Angles | No. of Blades | Part No. of Blades | Price | Part No. | Cutter Head Diameter | | Angles | No. of Blades | Part No. of Blades | Price |
|----------|----------------------|------|-----------|---------------|--------------------|-----------|----------|----------------------|------|-----------|---------------|--------------------|----------|
| | Inches | mm | | | | | | Inches | mm | | | | |
| CU 102 | 1-5/16" | 33,3 | 31° x 46° | 3/3 | 251 | \$ 100.00 | CU 609 | 1-1/4" | 31,8 | 46° | 5 | 250 | \$ 85.00 |
| CU 103 | 1-1/8" | 28,6 | 31° x 46° | 3/3 | 253 | 96.00 | CU 611 | 1-3/8" | 35 | 31° | 5 | 250 | 85.00 |
| CU 110 | .975" | 24,8 | 46° | 3 | 253 | 58.00 | CU 612 | 1-3/8" | 35 | 15° x 46° | 3/5 | 250 | 126.00 |
| CU 111 | 1" | 25,4 | 60° | 3 | 252 | 58.00 | CU 613 | 1-3/8" | 35 | 20° x 46° | 3/5 | 251/250 | 130.00 |
| CU 114 | 1-1/4" | 31,8 | 60° | 3 | 252 | 58.00 | CU 615 | 1-3/8" | 35 | 15° x 45° | 3/5 | 250 | 126.00 |
| CU 115 | .975" | 24,8 | 31° | 3 | 250 | 58.00 | CU 616 | 1-3/8" | 35 | 30° x 45° | 5/5 | 251 | 163.00 |
| CU 119 | 1" | 25,4 | 15° | 3 | 355 | 75.00 | CU 617 | 1-3/8" | 35 | 0° x 46° | 3/5 | 250 | 126.00 |
| CU 120 | 1" | 25,4 | 15° | 3 | 553 | 62.00 | CU 618 | 1-3/8" | 35 | 35° x 60° | 5/5 | 250/252 | 156.00 |
| CU 121 | 1" | 25,4 | 15° | 3 | 253 | 58.00 | CU 619 | 1-1/2" | 38 | 15° x 60° | 5/5 | 251/254 | 163.00 |
| CU 122 | .975" | 24,8 | 45° | 3 | 253 | 58.00 | CU 620 | 1-1/2" | 38 | 45° | 5 | 251 | 88.00 |
| CU 123 | .975" | 24,8 | 31° | 3 | 253 | 58.00 | CU 621 | 1-1/2" | 38 | 15° x 46° | 3/5 | 251 | 131.00 |
| CU 124 | 1-5/16" | 33,3 | 15° x 60° | 3/3 | 251/254 | 100.00 | CU 622 | 1-1/2" | 38 | 31° x 46° | 5/5 | 251 | 163.00 |
| CU 125 | 1" | 25,4 | 75° | 3 | 254 | 59.00 | CU 623 | 1-1/2" | 38 | 15° x 30° | 3/5 | 250 | 126.00 |
| CU 126 | 1" | 25,4 | 30° | 3 | 250 | 58.00 | CU 624 | 1-1/2" | 38 | 15° x 75° | 5/5 | 251/254 | 163.00 |
| CU 127 | .975" | 24,8 | 20° | 3 | 253 | 58.00 | CU 625 | 1-1/2" | 38 | 15° x 45° | 3/5 | 251 | 131.00 |
| CU 128 | 1-1/4" | 31,8 | 30° x 45° | 3/3 | 250 | 96.00 | CU 626 | 1-1/2" | 38 | 30° x 45° | 5/5 | 251 | 163.00 |
| CU 130 | .816" | 20,7 | 15° | 3 | ** | 66.00 | CU 627 | 1-1/2" | 38 | 30° | 5 | 250 | 85.00 |
| CU 131 | .850" | 21,6 | 45° | 3 | ** | 66.00 | CU 628 | 1-1/2" | 38 | 31° | 5 | 251 | 88.00 |
| CU 132 | .830" | 21,1 | 32° | 3 | ** | 66.00 | CU 629 | 1-1/2" | 38 | 15° | 5 | 250 | 85.00 |
| CU 133 | .874" | 22,2 | 60° | 3 | ** | 66.00 | CU 631 | 1-5/8" | 41,3 | 15° x 46° | 3/5 | 251 | 131.00 |
| CU 134 | .762" | 19,4 | 15° | 3 | ** | 66.00 | CU 632 | 1-5/8" | 41,3 | 31° x 46° | 5/5 | 251 | 163.00 |
| CU 135 | .830" | 21,1 | 45° | 3 | ** | 66.00 | CU 633 | 1-5/8" | 41,3 | 20° x 45° | 5/5 | 251 | 163.00 |
| CU 138 | .870" | 22,1 | 20° | 3 | ** | 66.00 | CU 634 | 1-5/8" | 41,3 | 45° | 5 | 251 | 88.00 |
| CU 142 | .925" | 23,5 | 32° | 3 | ** | 66.00 | CU 635 | 1-5/8" | 41,3 | 15° x 45° | 5/5 | 251 | 163.00 |
| CU 143 | .925" | 23,5 | 45° | 3 | ** | 66.00 | CU 636 | 1-5/8" | 41,3 | 30° x 45° | 5/5 | 251 | 163.00 |
| CU 144 | .758" | 19,3 | 32° | 3 | ** | 66.00 | CU 641 | 1-3/4" | 44,5 | 15° x 46° | 3/5 | 251 | 131.00 |
| CU 201 | 1-3/8" | 35 | 31° x 46° | 3 | 250/251 | 98.00 | CU 642 | 1-3/4" | 44,5 | 31° x 46° | 5/5 | 251 | 163.00 |
| CU 203 | 1-1/4" | 31,8 | 31° x 46° | 3/3 | 250 | 96.00 | CU 643 | 1-3/4" | 44,5 | 15° x 60° | 5/5 | 251/254 | 163.00 |
| CU 204 | 1-1/4" | 31,8 | 15° x 46° | 3/3 | 250 | 96.00 | CU 644 | 1-3/4" | 44,5 | 60° | 5 | 254 | 88.00 |
| CU 205 | 1-1/2" | 38 | 60° | 3 | 254 | 59.00 | CU 645 | 1-3/4" | 44,5 | 30° x 45° | 5/5 | 251 | 163.00 |
| CU 206 | 1-1/4" | 31,8 | 75° | 3 | 254 | 59.00 | CU 646 | 1-3/4" | 44,5 | 15° x 45° | 3/5 | 251 | 131.00 |
| CU 208 | 1-1/2" | 38 | 31° x 46° | 3/3 | 251/251 | 100.00 | CU 647 | 1-3/4" | 44,5 | 30° | 5 | 250 | 85.00 |
| CU 209 | 1-3/8" | 35 | 15° x 46° | 3/3 | 250 | 96.00 | CU 649 | 1-3/4" | 44,5 | 31° | 5 | 251 | 88.00 |
| CU 212 | 1-1/4" | 31,8 | 15° x 75° | 3/3 | 250/254 | 98.00 | CU 652 | 2" | 50,8 | 31° x 46° | 5/5 | 251 | 163.00 |
| CU 213 | 1-1/2" | 38 | 15° x 60° | 3/3 | 251/254 | 100.00 | CU 653 | 2" | 50,8 | 15° x 60° | 5/5 | 251/254 | 163.00 |
| CU 216 | 1-1/2" | 38 | 75° | 3 | 254 | 59.00 | CU 654 | 2" | 50,8 | 15° x 75° | 5/5 | 251/254 | 163.00 |
| CU 217 | 1-1/2" | 38 | 15° x 75° | 3/3 | 251/254 | 100.00 | CU 657 | 2" | 50,8 | 60° | 5 | 254 | 88.00 |
| CU 219 | 1-1/2" | 38 | 65° | 3 | 254 | 59.00 | CU 659 | 2" | 50,8 | 15° x 45° | 3/5 | 251 | 131.00 |
| CU 220 | 1-1/4" | 31,8 | 20° x 45° | 3/3 | 250 | 96.00 | CU 660 | 2" | 50,8 | 30° x 45° | 5/5 | 251 | 163.00 |
| CU 221 | 1-3/8" | 35 | 20° x 45° | 3/3 | 250/251 | 98.00 | CU 662 | 2-1/4" | 57,2 | 31° x 46° | 7/7 | 251 | 209.00 |
| CU 222 | 1-1/4" | 31,8 | 70° | 3 | 252 | 58.00 | CU 664 | 2-1/4" | 57,2 | 15° x 46° | 5/9 | 251 | 209.00 |
| CU 229 | 1-1/4" | 31,8 | 15° x 45° | 3/3 | 250 | 96.00 | CU 665 | 2-1/4" | 57,2 | 30° x 45° | 7/7 | 251 | 209.00 |
| CU 230 | 1-1/4" | 31,8 | 30° x 45° | 3/3 | 250 | 96.00 | CU 666 | 2-1/4" | 57,2 | 15° x 60° | 5/5 | 251/254 | 163.00 |
| CU 232 | 1-3/8" | 35 | 30° x 45° | 3/3 | 250/251 | 98.00 | CU 672 | 2-1/2" | 63,5 | 31° x 46° | 7/7 | 251 | 209.00 |
| CU 234 | 1-1/2" | 38 | 30° x 45° | 3/3 | 251 | 100.00 | CU 674 | 2-1/2" | 63,5 | 15° x 60° | 5/5 | 251/254 | 163.00 |
| CU 237 | 1-5/8" | 41,3 | 30° x 45° | 3/3 | 251 | 100.00 | CU 675 | 2-1/2" | 63,5 | 60° | 5 | 254 | 88.00 |
| CU 239 | 1-1/2" | 38 | 11° x 45° | 3/3 | 251 | 100.00 | CU 676 | 2-1/2" | 63,5 | 15° | 5 | 251 | 88.00 |
| CU 243 | 1-1/8" | 28,6 | 15° | 3 | 250 | 58.00 | CU 677 | 2-1/2" | 63,5 | 30° x 45° | 7/7 | 251 | 209.00 |
| CU 244 | 1-1/4" | 31,8 | 15° | 3 | 250 | 58.00 | CU 680 | 2" | 50,8 | 30° | 5 | 251 | 88.00 |
| CU 268 | 1-1/8" | 28,6 | 45° | 3 | 250 | 58.00 | CU 681 | 2" | 50,8 | 20° | 5 | 250 | 85.00 |
| CU 269 | 1-1/8" | 28,6 | 60° | 3 | 252 | 58.00 | CU 683 | 2" | 50,8 | 36° | 5 | 251 | 88.00 |
| CU 270 | 1-1/4" | 31,8 | 60° | 3 | 252 | 58.00 | CU 684 | 2" | 50,8 | 70° | 5 | 254 | 88.00 |
| CU 271 | 1-1/2" | 38 | 70° | 3 | 254 | 59.00 | CU 685 | 2-3/16" | 55,6 | 20° | 5 | 251 | 88.00 |
| CU 272 | 1-3/4" | 44,5 | 75° | 3 | 254 | 59.00 | CU 686 | 2" | 50,8 | 15° | 5 | 251 | 88.00 |
| CU 273 | 1-1/4" | 31,8 | 15° x 60° | 3/3 | 250/252 | 96.00 | CU 689 | 1-1/2" | 38 | 25° | 5 | 251 | 88.00 |
| CU 274 | 1-1/8" | 28,6 | 30° x 45° | 3/3 | 250 | 96.00 | CU 690 | 1-1/2" | 38 | 35° | 5 | 251 | 88.00 |
| CU 275 | 1-1/2" | 38 | 46° | 3 | 251 | 59.00 | CU 691 | 1-1/2" | 38 | 43° x 52° | 5/5 | 251 | 163.00 |
| CU 278 | 1-1/8" | 28,6 | 30° | 3 | 250 | 58.00 | CU 692 | 1-1/2" | 38 | 36° | 5 | 251 | 88.00 |
| CU 279 | 1-1/8" | 28,6 | 75° | 3 | 254 | 59.00 | CU 695 | 1-3/4" | 44,5 | 35° | 5 | 251 | 88.00 |
| CU 285 | 1-1/4" | 31,8 | 46° | 3 | 250 | 58.00 | CU 696 | 1-3/4" | 44,5 | 25° | 5 | 251 | 88.00 |
| CU 286 | 1-3/8" | 35 | 11° x 45° | 3/3 | 250 | 96.00 | CU 697 | 1-3/4" | 44,5 | 15° x 75° | 5/5 | 251/254 | 163.00 |
| CU 288 | 2" | 50,8 | 15° x 60° | 3/3 | 251/254 | 100.00 | CU 698 | 1-3/4" | 44,5 | 37-1/2° | 5 | 251 | 88.00 |
| CU 292 | 1-3/4" | 44,5 | 15° x 60° | 3/3 | 251/254 | 100.00 | CU 699 | 1-3/4" | 44,5 | 70° | 5 | 254 | 88.00 |
| CU 293 | 1-3/4" | 44,5 | 60° | 3 | 254 | 59.00 | CU 701 | 1-1/4" | 31,8 | 0° | 3 | 250 | 58.00 |
| CU 297 | 1-1/2" | 38 | 15° x 70° | 3/3 | 251/254 | 100.00 | CU 720 | 1-1/2" | 38 | 0° | 3 | 251 | 59.00 |
| CU 299 | 1-1/8" | 28,6 | 30° | 3 | 253 | 58.00 | CU 740 | 1-3/4" | 44,5 | 0° | 3 | 251 | 59.00 |
| CU 602 | 1-1/4" | 31,8 | 31° | 5 | 250 | 85.00 | CU 750 | 2" | 50,8 | 0° | 3 | 251 | 59.00 |
| CU 603 | 1-1/4" | 31,8 | 15° x 31° | 3/5 | 250 | 126.00 | CU 760 | 2-1/4" | 57,2 | 0° | 3 | 251 | 59.00 |
| CU 604 | 1-1/4" | 31,8 | 15° | 5 | 250 | 85.00 | CU 8031 | 1-1/4" | 31,8 | 80° | 5 | 254 | 152.00 |
| CU 605 | 1-1/4" | 31,8 | 65° | 3 | 254 | 59.00 | CU 8038 | 1-1/2" | 38 | 80° | 5 | 254 | 152.00 |
| CU 606 | 1-1/4" | 31,8 | 25° | 5 | 250 | 85.00 | CU 8044 | 1-3/4" | 44,5 | 80° | 5 | 254 | 152.00 |
| CU 607 | 1-1/4" | 31,8 | 30° | 5 | 250 | 85.00 | CU 8050 | 2" | 50,8 | 80° | 7 | 254 | 170.00 |
| CU 608 | 1-1/4" | 31,8 | 45° | 5 | 250 | 85.00 | | | | | | | |

** Blades are fixed, not replaceable

NEWAY PRICE LIST

STANDARD SERIES SOLID PILOTS

FRACTIONAL SIZES

*Special run pilot, additional \$5.00

| Part No. | Price | Part No. | Price |
|---|----------|---|----------|
| 140-1/4" Std. (Also -3*, -2, -1, +1, +2*, +3*)..... | \$ 19.50 | 140-3/8" Std. (Also -4*, -3, -2, -1, +1, +2, +3, +4, +5, +6)..... | \$ 21.50 |
| 140-9/32" Std. | 19.50 | 140-7/16" Std. (Also -2*, -1*, +1*, +2*)..... | 21.50 |
| 140-5/16" Std. (Also -3, -2, -1, +1, +2, +3, +4, +5)..... | 19.50 | 140-29/64" Std.* (Also -2*, -1*, +1*, +2*)..... | 21.50 |
| 140-11/32" Std. (Also -4, -3, -2, -1, +1, +2, +3, +4*)..... | 19.50 | 140-1/2" Std.* (Also -2*, -1*, +1*, +2*)..... | 21.50 |

METRIC SIZES

| | | | |
|---|-------|---|-------|
| 140-5.0mm (Also 4,98mm, 5,02mm)..... | 19.50 | 140-8.5mm (Also 8,48mm, 8,52mm)..... | 19.50 |
| 140-5.5mm (Also 5,48mm, 5,52mm, 5,55mm)..... | 19.50 | 140-9.0mm (Also 8,98mm, 9,02mm)..... | 19.50 |
| 140-6.0mm (Also 5,98mm, 6,02mm)..... | 19.50 | 140-9.5mm (Also 9,48mm, 9,52mm)..... | 21.50 |
| 140-6.6mm (Also 6,58mm, 6,62mm)..... | 19.50 | 140-10.0mm (Also 9,98mm, 10,02mm)..... | 21.50 |
| 140-7.0mm (Also 6,98mm, 7,02mm)..... | 19.50 | 140-11.0mm (Also 10,98mm, 11,02mm)..... | 21.50 |
| 140-7.5mm (Also 7,48mm, 7,52mm)..... | 19.50 | 140-12.0mm (Also 11,98mm, 12,02mm)..... | 21.50 |
| 140-8.0mm (Also 7,98mm, 8,02mm, 8,05mm*)..... | 19.50 | | |

SMALL SERIES SOLID PILOTS

(For use w/ 100 series cutters)

FRACTIONAL SIZES

*Special run pilot, additional \$5.00

| Part No. | Price | Part No. | Price |
|----------------------------------|----------|--------------------------|----------|
| 100-1/4" Std. (Also -1, +1)..... | \$ 14.50 | 100-5/16" (Also +1)..... | \$ 14.50 |
| 100-9/32" | 14.50 | 100-11/32" | 14.50 |

METRIC SIZES

| | | | |
|--|----------|--|----------|
| 100-3,8mm (Also 3,82mm)..... | \$ 14.50 | 100-6,0mm (Also 5,98mm, 6,02mm, 6,05mm)..... | \$ 14.50 |
| 100-4,0mm (Also 4,02mm, 4,05mm*)..... | 14.50 | 100-6,5mm | 14.50 |
| 100-4,5mm (Also 4,48mm, 4,52mm, 4,55mm)..... | 14.50 | 100-6,6mm (Also 6,58mm, 6,62mm, 6,65mm)..... | 14.50 |
| 100-4,8mm | 14.50 | 100-7,0mm (Also 7,02mm, 7,05mm)..... | 14.50 |
| 100-5,0mm (Also 4,98mm, 5,02mm)..... | 14.50 | 100-7,5mm* | 14.50 |
| 100-5,5mm (Also 5,48mm*, 5,52mm, 5,55mm*)..... | 14.50 | 100-8,0mm | 14.50 |
| 100-5,55mm* -short..... | 14.50 | 100-9,0mm | 14.50 |

EXPANDABLE PILOTS

| 120 SERIES - \$ 35.50 (For use w/ 100 series cutters) | | 150 SERIES - \$ 35.50 | | | | 200 SERIES - \$ 38.50 | | |
|--|-----------|-----------------------|------------|-----------|------------|-----------------------|-----------|------------|
| Part No. | Part No. | Part No. | Part No. | Part No. | Part No. | Part No. | Part No. | Part No. |
| 120-1/4" | 120-6,5mm | 150-1/4" | 150-13/32" | 150-7,0mm | 150-10mm | 200-5/16" | 200-1/2" | 200-10,5mm |
| 120-9/32" | 120-7mm | 150-9/32" | 150-7/16" | 150-7,5mm | 150-10,5mm | 200-11/32" | 200-8mm | 200-11mm |
| 120-5/16" | 120-7,5mm | 150-5/16" | 150-1/2" | 150-8,0mm | 150-11,0mm | 200-3/8" | 200-8,5mm | 200-11,5mm |
| 120-11/32" | 120-8mm | 150-11/32" | 150-5,5mm | 150-8,5mm | 150-11,5mm | 200-25/64" | 200-9mm | 200-12mm |
| 120-5,5mm | 120-8,5mm | 150-3/8" | 150-6,0mm | 150-9,0mm | 150-12,0mm | 200-13/32" | 200-9,5mm | 200-12,5mm |
| 120-6mm | | 150-25/64" | 150-6,5mm | 150-9,5mm | 150-12,5mm | 200-7/16" | 200-10mm | 200-13mm |

EXPANDABLE PILOTS - SPARE PARTS

| Part No. | Price | Part No. | Price |
|-------------------------|----------|------------------|----------|
| -Suffix | | -Suffix | |
| -1 Stem 120 Series..... | \$ 20.75 | -2 Collet..... | \$ 12.00 |
| -1 Stem 150 Series..... | 20.75 | -3 Expander..... | 4.25 |
| -1 Stem 200 Series..... | 23.75 | -4 Nut..... | 2.50 |
| | | -5 Spacer..... | 4.00 |

Note: Order for expandable pilot spare parts must include PILOT PART NUMBER, SUFFIX, and DESCRIPTION.

NEWAY PRICE LIST

VFR-1000 MOTORIZED VALVE REFAKER

VFR PARTS & ACCESSORIES

| Part No. | | Price |
|----------|---|---------|
| VFR DISC | Sanding Discs (4/pkg)..... | \$ 5.60 |
| VFR 72 | Carbide Insert for Standard Valves..... | 7.95 |
| VFR 74 | Carbide Insert for Titanium/Stainless Valves..... | 7.95 |
| VFR 75 | Carbide Insert for Stellite/Very Hard Valves..... | 7.95 |
| VFR FUSE | 4 Amp Fuse..... | 1.00 |
| VFR BULB | 25W R14 Bulb..... | 6.50 |

VFR COLLETS

| Part No. | | Price |
|----------|--------------------|----------|
| VFRC 40 | 4,0mm..... | \$ 30.00 |
| VFRC 50 | 5,0mm..... | 30.00 |
| VFRC 55 | 5,5mm - 7/32"..... | 30.00 |
| VFRC 60 | 6,0mm..... | 30.00 |

VFR COLLETS

| Part No. | | Price |
|-----------|----------------------|----------|
| VFRC 65 | 6,5mm - 1/4"..... | \$ 30.00 |
| VFRC 66 | 6,6mm..... | 30.00 |
| VFRC 70 | 7,0mm..... | 30.00 |
| VFRC 932 | 9/32"..... | 30.00 |
| VFRC 80 | 8,0mm - 5/16"..... | 30.00 |
| VFRC 85 | 8,5mm..... | 30.00 |
| VFRC 1132 | 11/32"..... | 30.00 |
| VFRC 90 | 9,0mm..... | 30.00 |
| VFRC 95 | 9,5mm - 3/8"..... | 30.00 |
| VFRC 100 | 10,0mm..... | 30.00 |
| VFRC 105 | 10,5mm - 13/32"..... | 30.00 |
| VFRC 110 | 11,0mm - 7/16"..... | 30.00 |
| VFRC 115 | 11,5mm..... | 30.00 |
| VFRC 120 | 12,0mm..... | 30.00 |
| VFRC 125 | 12,5mm..... | 30.00 |
| VFRC 12 | 1/2"..... | 30.00 |

SEAT CUTTER PARTS

CUTTER PARTS & ACCESSORIES

| Part No. | | Price |
|----------|--|---------|
| HK 564 | 5/64" Hex Driver..... | \$ 2.00 |
| HK 332 | 3/32" Hex Key..... | .25 |
| PPP 245 | Pilot Puller Pin..... | .25 |
| CB 267 | Cleaning Brush..... | 1.50 |
| KACC 246 | Accessories Kit (above four items)..... | 4.00 |
| KACC 100 | Repair Kit..... | 15.50 |
| S 260 | 5-40 Flat Head Screw..... | .25 |
| W 265 | Wedge for heads over 25,4mm (1") diameter..... | .25 |
| W 266 | Wedge for 25,4mm (1") diameter heads..... | .25 |

**CUTTERS FOR G.M. 4-VALVE
EMD ENGINE HEADS**

| Part No. | | Price |
|----------|-------------------------|-----------|
| CU 4220 | 2-1/2" 63,5mm 20° 9 251 | \$ 396.00 |
| CU 4230 | 2-1/2" 63,5mm 30° 9 251 | 396.00 |
| CU 4265 | 2-1/4" 57,2mm 65° 7 254 | 377.00 |

WRENCHES

| Part No. | | Price |
|------------|--|----------|
| TWEZ | Easy-Turn Wrench (includes TW-503-1 adaptor)..... | \$ 49.50 |
| TW 505 | 1/2" Hex Nylon Fiber T-Wrench (for Standard Series Cutters)..... | 8.00 |
| TW 513 | 3/8" Hex Nylon Fiber T-Wrench (for Small Series Cutters)..... | 8.00 |
| TW 503 | 1/2" Hex Metal T-Wrench (for Standard Series Cutters)..... | 14.00 |
| TW 503-1 | Adaptor, 1/2" to 3/8" (for Small Series Cutters)..... | 6.25 |
| TW 503-8 | 503 Extension, 8" (203mm)..... | 16.00 |
| TW 503-10 | 503 Extension, 10" (255mm)..... | 18.00 |
| TW 503-12H | 503 Extension, 12" (305mm), with welded hub..... | 28.50 |

TOOL CASES

| Part No. | Capacity | Price |
|----------|--|---------|
| CA 303 | Case, 3 Cutters (Small Series Cutters only)..... | \$ 9.50 |
| CA 160 | Case, 6 Cutters..... | 12.50 |
| CA 497 | Case, 11 Cutters..... | 19.75 |

POWER UNIT PARTS & ACCESSORIES

| Part No. | | Price |
|-------------|---|-----------|
| PU 1517-A | 1/2" Hex Socket Transmission..... | \$ 210.00 |
| PU 1517-B | 5/8" Hex Socket Transmission..... | 210.00 |
| PU 1517-C | 3/4" Hex Socket Transmission..... | 260.00 |
| PU 1703 | Trolley..... | 143.00 |
| PU 1804 | Motor, Control Box, Foot Switch Assembly..... | 545.00 |
| PU 1804-230 | Motor, Control Box, Foot Switch Assembly (230 V)..... | 545.00 |
| PU 1801 | Motor Control Box Assembly..... | 495.00 |
| PU 042501 | Foot Switch for 1800/1900 Power Unit..... | 49.00 |

| Part No. | | Price |
|----------|---|-----------|
| T5FT | 5' Track..... | \$ 132.50 |
| T4FT | 4' Track..... | 106.00 |
| T3FT | 3' Track..... | 79.50 |
| TFT | Track per 1 Foot..... | 26.50 |
| PU 1705 | Head Stands — pair..... | 49.00 |
| PU 707 | Cutting Fluid, One Pint (spray bottle)..... | 8.50 |
| PU 708 | Cutting Fluid, One Gallon..... | 18.00 |

MISCELLANEOUS

| Part No. | | Part No. | |
|----------|---|----------|---|
| ACT | Video Tape, Automotive (Covers both valve seat reconditioning and valve refacing)..... | PET | Video Tape, Small Engine (Covers both valve seat reconditioning and valve refacing)..... |
| | \$ 14.95 | | \$ 14.95 |